

HANDYNEB CLASSIC
Aerosol Therapy
Compressor Nebulizer System

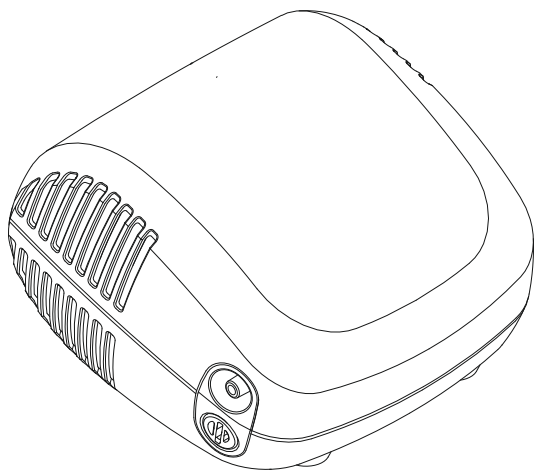

INSTRUCTION BOOKLET
&
WARRANTY CARD

INTRODUCTION

Your doctor has prescribed a liquid medication to treat your respiratory condition. To best utilize this liquid medication, he has prescribed a **HANDYNEB CLASSIC** brand compressor/nebulizer.

Your **HANDYNEB CLASSIC** compressor & nebulizer works to convert the medication to a high-quality mist of fine particles that penetrates deep into the lungs.

Be sure that you read and understand the information in this instruction guide. By following these simple instructions and the advice of your physician, your compressor will become an effective addition to your therapeutic routine.

Carefully read these instructions and keep them in a safe place for future reference. Use the unit only as described in this instruction booklet. Not Following the instruction in this booklet may cause hazards.

This medical device is to be used only upon medical prescription. This medical device for home use only.

The contents of this booklet are in no way to be understood as medical advice and under no circumstances replace medical / clinical judgement, advice & experience.

Data given is correct to the best of our knowledge at the time of going to print . No responsibility accepted for any misprint, admission or omission.



This device is not to be used in life threatening situations or to treat life threatening conditions

IMPORTANT PARTS OF YOUR NEBULIZER KIT

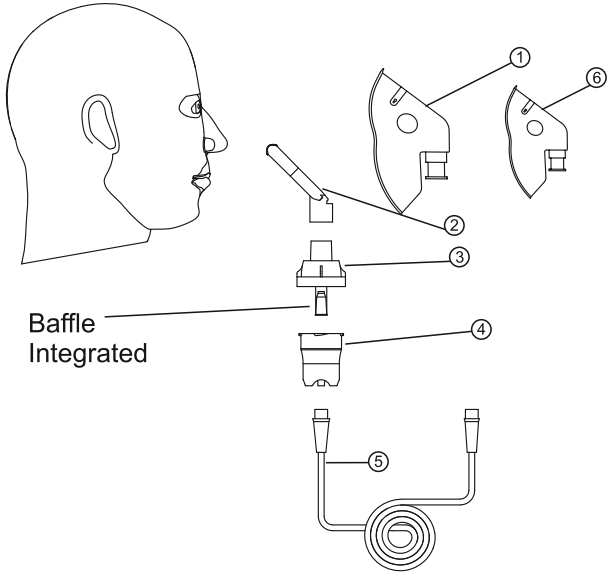

Note : Nebulizer Kit is referred to Nebulizer in this booklet

1. Adult Mask
 2. Adult Mouthpiece
 3. Medicine Bottle Cap with integrated baffle
 4. Medicine Bottle Cup
 5. Air Tube
 6. Child Mask
- Replacement Nebulizer Kit Part No.:-S011-1

IMPORTANT: Warrantee is not applicable for kit and accessories components. Kit and accessories should be replaced from time to time as needed or as per doctor's advise.

(Accessories included as a standard with the appliance might differ picture for information only.)



Use only compatible Nebulizer kit Reorder No. S011-1 with this Nebulizer.

IMPORTANT PARTS OF YOUR COMPRESSOR

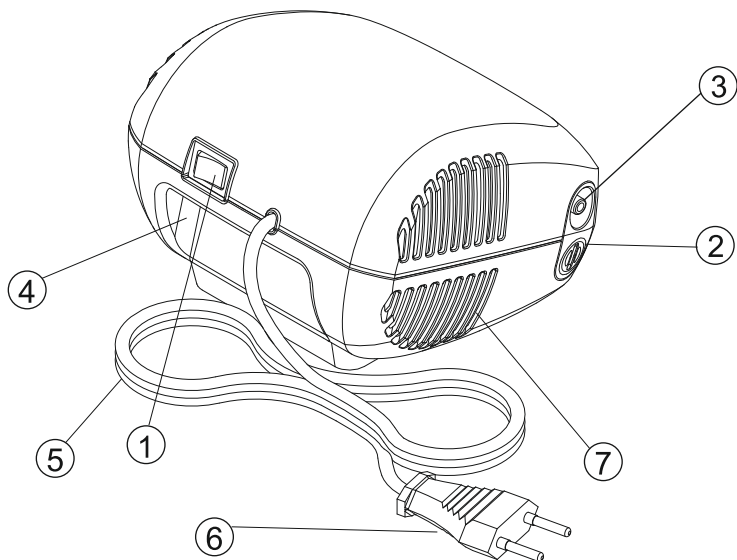

1. Power Switch
2. Filter
3. Air-outlet connector
4. Carrying handle space
5. Power Cord
6. Power Plug
7. Ventilation Slot

Note : Picture for illustration purpose only actual product may vary.

TECHNICAL FEATURES

| | |
|-----------------------------|---|
| Electrical Requirements | 195 -253 V~, / 50 Hz |
| Power Consumption | 100 Watt |
| Fuse | 02A - 250V |
| Alarms | None |
| ON Time / / OFF Time | 60 Minutes / 30 Minutes |
| Electrical Shock Protection | Class II, Type B |
| Compressor Air output | 2.0 - 3.1 bar // 8.5 Lpm non adjustable |
| Dimensions // Weight | 140mm x 146mm x 101mm, 1.35kg approximate |
| Sound level at 1 meter | 60 dBA max |
| Medicine Bottle capacity | 8 ml max – Recommended fill level 6 ml |
| Operating requirements | Temperature: min. +5° C – max 40°C Humidity: 15 – 95% RH non condensing Pressure: 700 hPa, max 1060 hPa |
| Ingress protection | IP21 |
| Storage Temperature Range | Temperature: min. -20° C – max 70°C Humidity: 5 – 95% RH Non-Condensing Pressure: 700 hPa, max 1060 hPa |

Aerosol Data as per 27427:2019 - The aerosol characteristics tabled below are determined as per 27427:2019 using Salbutamol and with adult breathing patterns. The aerosol characteristics may vary if other solutions or suspensions are used especially if they have greater viscosity.

| Parameters | UOM | Minimum com-pressor flow | Nominal com-pressor flow | Maximum com-pressor flow |
|---|--------------|--------------------------|--------------------------|--------------------------|
| Gas Flow | Liter/minute | 4 | 6 | 8 |
| Test Solution | | salbutamol | salbutamol | salbutamol |
| Fill volume | ml | 6 | 6 | 6 |
| MMAD | um | 4.9 | 4.2 | 3.3 |
| Respirable fraction [% < 5 µm] | % | 52.8 | 61.3 | 70.3 |
| Aerosol fraction [% < 2 µm] | % | 15.8 | 25.7 | 34.1 |
| Aerosol fraction [% > 2 µm < 5 µm] | % | 37.0 | 35.6 | 36.2 |
| Aerosol fraction [% > 5 µm] | % | 47.2 | 38.7 | 29.7 |
| Aerosol output | ml | 0.39 | 0.42 | 0.43 |
| Aerosol Output Rate | ml/minute | 0.21 | 0.26 | 0.30 |
| Percentage of fill vol emitted per minute | % / minute | 3.5% | 4.3% | 5.0% |
| Nebulization time | minute | 22.86 | 19.19 | 16.83 |
| Residual volume | ml | 1.2 | 1.01 | 0.95 |



The nebulizer and its components are not tested with all possible solutions/suspensions/emulsions to be used in the nebulizer. Please consult medicine manufacturers data-sheet for any specific compatibility requirements with nebulizer components.

INTENDED USE

This product is intended to inhalation of medication in atomized form for relief from respiratory disorders.

Intended Use/ Indication

The Nebulizer is intended to turn liquid medication into an aerosol from that is delivered directly to breathing airways of adult or pediatric patients who have been prescribed inhalation therapy or medication.

Intended Patients Population

All Patient population irrespective of age and gender , except for infants and neonates. Not recommended for Infants & Neonates.

Intended Users

Certified medical experts such as, doctors, nurses therapists etc. Caretaker or patient under guidance of qualified medical experts User capable of reading and understanding the contents of this INSTRUCTION BOOKLET and general understanding of the product

Environment

The product can be used for indoor use only in a doctors office, home or healthcare facility. Please see detail environmental conditions for use, transport and storage in technical details.

Durable Period

The durable period is based on use to nebulize saline 3 times a day for 10 minutes each provided the product is used in accordance with this INSTRUCTION BOOKLET

| | |
|---------------------------|----------|
| Compressor | 5 Years |
| Nebulizer Medicine Bottle | 1 Year |
| Mouthpiece | 1 Year |
| Air Tube | 1 Year |
| Air Filter | 6 Months |
| Adult Mask | 1 Year |
| Child Mask | 1 Year |



Precautions

The operating, maintenance and cleaning procedures, warnings and cautions as instructed in this INSTRUCTION BOOKLET must be followed.

IMPORTANT SAFETY INSTRUCTION

Please read the information in the instruction manual and any other literature included with the product before using the device. It is important to follow all instructions in this manual including Safety instructions. Failure to follow the instructions may result in a potentially hazardous situation resulting in serious injury.

- For type, dose, and regime of medication follow the instructions of your doctor or respiratory therapist
- If you feel anything unusual during use, stop using the device immediately and consult your doctor.
- Clean and disinfect the nebulizer kit, mask, mouthpiece or nosepiece before using them for the first time after purchase.
- If the device has not been used for a long period of time, or if more than one person uses the same device, clean and disinfect the nebulizer kit, mask, mouthpiece or nosepiece before using them.
- Be sure to wash the parts after use, and ensure that they are thoroughly disinfected and dried, and stored in a clean location in a sealed bag.
- Do not store the nebulizer kit parts while there is moisture, medicine, cleaning solution or medication remaining inside.
- Do not use or store the device where it may be exposed to high humidity, noxious fumes, volatile substances, flammable gases, heat sources, corrosive fluids and gases.
- Do not cover the compressor with a blanket, pillow, towel, or any other type of cover during use. Do not block the ventilation slots. Never place the device where the ventilation slots may be obstructed during operation. Keep the air openings free of lint, hair and the like
- Never place the device on a soft surface, such as a bed or couch, where the ventilation slots may be blocked
- Do not block the air filter cover
- Use fresh medication each time, always dispose of any remaining medication after use
- Do not use in anesthetic or ventilator breathing circuits
- Do not use attachments not recommended by the manufacturer
- Do not operate unit in a backpack or carrying bag
- Never plug, unplug or handle the device with wet hands.
- The compressor and power cord are not waterproof. Do not spill water or other liquids on these parts. If liquid does spill on these

Cont. →

IMPORTANT SAFETY INSTRUCTION

parts, immediately unplug the power cord and wipe off the liquid with gauze or other absorbent material & ensure it is returned to an authorized service dealer .

- Do not immerse the compressor in water or other liquid
- Do not operate the device with a damaged power cord or plug.
- Keep the power cord away from heated surfaces.
- Do not use while bathing.
- Do not place or store product where it can fall or be pulled into a tub or sink.
- Never submerge the unit in water; should this accidentally occur, unplug immediately do not reach for the submerged unit, always unplug first. After removing the unit from water, do not use again, ensure it is returned to an authorized service dealer.
- The product should never be left unattended when plugged In.
- Do not use this product with a DC to AC converter, or with any AC voltage and/or frequency other than specified
- If necessary, use adapters or extension leads which conform to the safety standards in force, paying attention not to exceed the rated current value and maximum power value indicated on the adapter
- The power cord and air tube should be kept away from children, invalids it may cause strangulation hazard
- Provide close supervision when this device is used by, on, or near children or invalids , or persons who cannot express their consent
- Do not use the device while sleeping or if drowsy.
- Keep the device and accessories out of the reach of unsupervised infants and children. The device may contain small pieces that can be swallowed and cause choking hazard
- Make sure that the parts are attached correctly.
- Make sure that the air filter is clean. If the air filter has changed color, or has been used on average for more than 60 days, replace it with a new one.
- Do not tilt the nebulizer kit at an angle of greater than 45 degrees in all directions shake it while in use.
- Do not use or store the device while the air tube is creased or kinked.
- Use only original nebulizer parts, air tube, air filter and air filter cover
- There are no interdependent controls in the device.

Cont. →

IMPORTANT SAFETY INSTRUCTION

- Fill medicine cup as per recommended in specification. Do not overfill.
- Do not subject the device or the parts to any strong shocks such as dropping the device on the floor.
- Do not distort the vaporizer head (baffle) , or jab the nozzle of the medication tank with a pin or any sharp object
- Do not insert fingers or objects inside the compressor
- Do not disassemble or attempt to repair the device there are no user serviceable parts inside
- Do not use a microwave oven, dish dryer or hair dryer to dry the device or the parts.
- Approved for human use only.
- When using the device, the main unit may become warm to touch. Do not touch the main unit for other than necessary operation such as turning off the power while nebulizing.
- To avoid injury to the nose mucosa, do not squeeze the nosepiece into the back of the nose.
- Do not use Ethylene Oxide Gas disinfection or low temperature plasma sterilizer to disinfect the device.
- Always unplug the device from the power outlet after use and before cleaning.
- Plug the device into the appropriate voltage outlet. Do not overload power outlets or use extension cords.
- Do not misuse the power cord.
- Do not wind the power cord around the compressor.
- Changes or modifications will void the user warranty.
- Do not pull the power cord strongly.
- Do not carry the device with the power cord
- Inspect the device and parts before using them each time, and check that there are no problem. In particular, be sure to check the following :
 - That the nozzle or air tube are not damaged.
 - That the nozzle is not blocked.
 - That the compressor operates normally
- When using this device, there will be some noise and vibration caused by the pump in the compressor. There will also be some noise caused by the emission of compressed air from the

IMPORTANT SAFETY INSTRUCTION

nebulizer kit. This is normal and does not indicate a malfunction

- Operate the device only as intended. Do not use the device for any other purpose
- Make sure that the air tube is securely attached to the compressor and nebulizer kit, and does not come loose.
- To completely isolate the device from the power source unplug the plug from the power source.
- Keep the Nebulizer Medicine Bottle Cup in Vertical position during use.
- The Nebulizer dose not have any interdependent controls.
- The nebulizing system is or is not suitable for use in an anesthetic breathing system or a ventilator breathing system.

CONTRAINDICATIONS

Contraindications associated with specific medications being delivered may exist. Pharmaceutical information in the package insert should be consulted for relative contraindications.



















Should not be used for patients with known allergies to medication preservatives and other excipients.

Should not be used unsupervised on children, unconscious patients or patients not able to express their consent.

Should not be used while sleepy or drowsy.

Nebulizers should not be used on patients who are not breathing on their own or those who are unconscious or those who can not express their feelings to the caregiver.

SYMBOLS

| Symbol | Title |
|---|------------------------------|
|  | Alternating Current |
|  | Type B |
|  | Double Insulated |
|  | Refer to the User Manual |
|  | Serial Number |
|  | Caution |
|  | OFF Position |
|  | ON Position |
| IFU | Instruction for Use |
|  | Not for general waste |
|  | Manufacturer |
|  | Date of Manufacturing |
|  | Unique Device Identification |
| CE | CE |
|  | Medical Device |
|  | Keep Dry |
|  | Ingress Protection |
|  | Temperature Limit |
|  | Humidity Limit |
|  | Air Pressure Limit |

HOW TO OPERATE YOUR COMPRESSOR & NEBULIZER

Before initial operation, your nebulizer should be cleaned following cleaning instructions, or as recommended by your Physician

- Make sure the power switch is in the "OFF"(● OFF) position
- Un- wrap power cord
- Place compressor so that the rubber feet are resting on a level, sturdy surface and upon which the controls can be easily reached when seated. Never block the air openings of the product or place it on a bed or couch where the air openings may be blocked.
- Plug power cord into an appropriate wall outlet.

⚠ Compressor/nebulizer must be operated on the specified power source to avoid risk of electric shock and damage to the compressor. See instrument bottom panel for power details

⚠ Wash hands. Ensure Hands are dry

- Connect one end of the nebulizer tubing to the compressor air- outlet connector (**NOTE** during high humidity weather conditions, condensation, water build up can occur in the nebulizer tubing)
- Assemble clean nebulizer parts by placing baffle down in medication cup:- Add prescribed medication into the medication cup
- Assemble mouthpiece, or mask and T-piece (if applicable) and insert into the top of the nebulizer cap.
- Attach tubing to nebulizer air-inlet connector
- Press the power switch "On" (I ON) Position to start the compressor as aerosol being to flow, inhale deeply and slowly, hold & then exhale slowly. Follow instructions as given by your physician If treatment needs to be interrupted, simply press power switch "(● OFF)"

- When treatment is complete, turn unit “OFF”(●OFF) by pressing the power switch to the “OFF” position. Unplug the unit from the wall power outlet. Clean the appliance & accessories as Indicated

- It may happen that during the use of the nebulizer visible humidity deposits form in the connection tube disconnect the tube from the nebulizer and let it dry using the compressor air flow.

⚠ Some nebulizers are rated for intermittent operation; Please do not operate continuously for more than rated time. See instrument bottom panel for details .

⚠ Allow specified off period for instrument to cool before resuming use

- The nebulizer is made with high quality of plastic which is safe for use. However due to variety and continuous evolution of the drugs, the possibility of a chemical interaction cannot be excluded. Once opened, the drug should be used as soon as possible, and prolonged contact between drug and nebulizer should be avoided.

⚠ The use of ESSENTIAL OILS can cause damage to the Nebulizer.

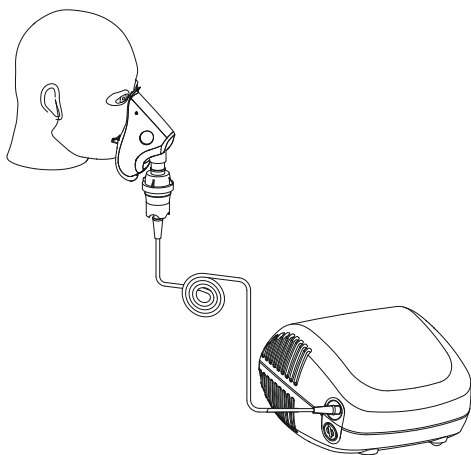

NEBULIZER KIT CLEANING

All parts of the nebulizer kit, except tubing, should be cleaned according to the following instructions. Your physician may specify a certain cleaning procedure. If so, follow their recommendations.

⚠ To prevent possible risk of infection from contaminated medication, cleaning of the nebulizer is recommended after each aerosol treatment. Disinfecting is recommended once a day.

Clean After Every Use

- With power switch in the “OFF”(● OFF) position, unplug power plug.
- Disconnect tubing from the air-inlet connector and set aside.
- **Disassemble mouthpiece, or mask from cap. Open nebulizer by turning cap counter clock wise an**
- **Wash all items, except tubing, in a warm water / dishwashing detergent solution. Rinse under warm tap water remove detergent residue. Allow to air dry.**

Disinfect Daily

- **Using a clean container or bowl, soak items for 30 minutes in three parts warm water & one part medical bacterial germicidal disinfectant available through your provider. With clean hands, remove items from disinfectant solution, rinse under warm tap water, and air dry on clean paper towel. Store in a zip lock bag.**
- Keep the outer surface of the tubing dust free by wiping regularly. Nebulizer tubing does not have to be washed because only filtered air passes through it

Note : Do not towel dry nebulizer parts, this could cause contamination. It is recommended to replace the medication nebulizer medicine cup once a year or as directed by your doctor.

⚠ The Nebulizer kit is recommended for single patient use only to prevent cross infection

⚠ **To prevent possible risk of infection from contaminated cleaning solutions, always prepare fresh solution, for each cleaning cycle and discard solution after each use.**

⚠ **Clean the nebulizer kit before using for first time after purchase**

COMPRESSOR CLEANING

● With power switch in the “OFF” (● OFF) position, unplug power from wall outlet plug.

● Wipe outside of the compressor cabinet with a clean damp cloth to keep dust free

⚠ Do not submerge in water, doing so will result in compressor damage.

MAINTENANCE

⚠ Electric shock hazard. Do not disassemble compressor cabinet. All disassembly and maintenance must be done by a qualified service provider.

⚠ To completely isolate the device from the power source unplug the power plug from the power source

FUNCTIONAL TEST

● Before use check the parts are connected properly and securely

● The connections are not loose

● There is no damage to the parts

● The nozzle and tube is not blocked or and the compressor operated normally

FILTER CHANGE INSTRUCTION

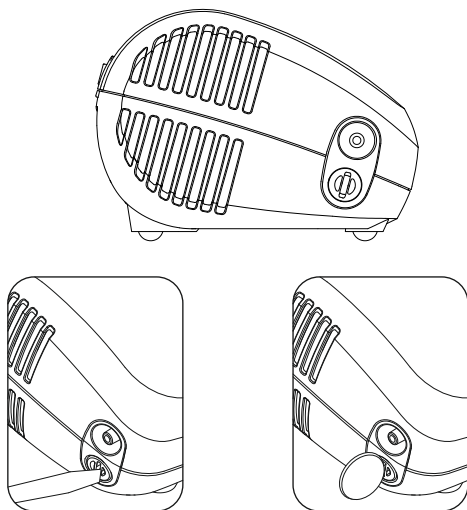

- Filter should be changed every 6 months or sooner if filter discolors.
- Remove filter by turning the filter cover anticlockwise and pulling out of the unit. Discard old filter.
- Replace with a new filter. Additional filters should be purchased from your provider.
- Push new filter into position. Turn the filter cover clockwise to fit in position.
- You can use a small coin or flat screwdriver to open filter.
- Replacement filter kit Part No. :-PA 0062

⚠ Caution : Do not reuse or wash filter or substitute any other material such as cotton for a air-inlet filter. It will result in compressor damage

ELECTROMAGNETIC COMPATIBILITY

This aerosol therapy unit is designed to meet the current requirements for electromagnetic compatibility. However if you suspect that the unit is interfering with the operation of your TV, radio or other electrical appliance, try relocating the unit until the interference ceases. Alternatively try plugging the unit into a different power socket.

The manufacturer reserves the right to introduce technical changes.

Do not use devices that generate strong electromagnetic fields near this device. It may result in incorrect operation and potentially hazardous situation.

This medical device confirms to IEC 60601-1-2:2014+AMD1:2020 standard for electromagnetic immunity and emissions.

Further documentation in accordance with this EMC standard is available the address mentioned in this instruction manual or at www.medtechlife.com Refer to the EMC information on the website.

STATEMENT OF INTENDED USE

The Compressor Nebulizer includes an AC powered air compressor that provides a source of compressed air for home health care use. The compressor is used in conjunction with a jet (pneumatic) nebulizer to convert certain inhalable drugs into an aerosol form for inhalation by a patient. The device can be used with adult or pediatric patients.

Note:

If using a nebulizer other than one that come with this device verify that the Pressure and/or flow characteristics of the nebulizer while driven by the compressor meet the nebulizer manufacturer's recommendation.

DISPOSAL



This product or its accessories should not be disposed of with other household wastes at the end of its durable life.



Users are advised to check their local waste disposal guidelines for correct separation and disposal of the device and accessories

STATEMENT OF REPORTING IN CASE OF ADVERSE EVENT

In case of any adverse event noted, contact manufacturer or authorized representative and competent authority of the member state where user/ patient is established.

HOW TO USE

STEP-1

Open the Medicine Cup Cap and put the medicine from Medicine Vial into the Medicine Cup.
Maximum 8ml medicine to be filled in the Medicine Cup.
Do not over fill.

कैसे उपयोग करे
कदम - १

दवाई के कप का ढक्कन खोलें
ओर दवाई को बोतल से दवाई
के कप में डालें।

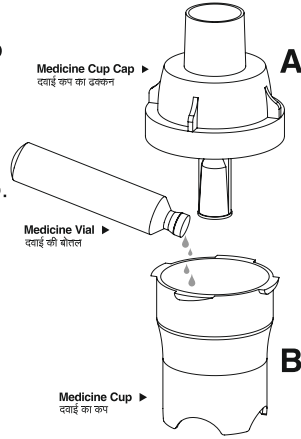

HOW TO USE

STEP-2

Close the Medicine Cup cap tightly

कैसे उपयोग करे
कदम - २

दवाई कप का ढक्कन
कसकर बंद करें।

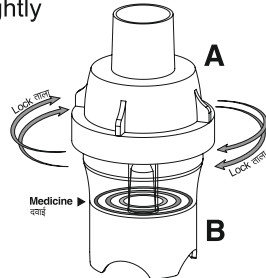

HOW TO USE

STEP-3

Attach one end of the tube to the Medicine Cup.

कैसे उपयोग करे
कदम - ३

नली का एक सीरा दवाई
के कप के साथ जोडे ।

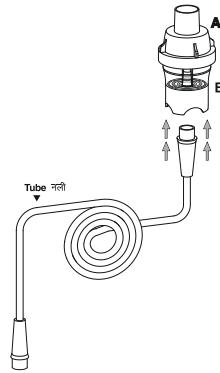

HOW TO USE

STEP-4

Attach the other end of the tube to the Nebulizer Machine at the Air Outlet Port

कैसे उपयोग करे
कदम - ४

नली का दूसरा सीरा नेबयूलाईझर
मशीन के हवा बाहर जानेवाले पोर्ट
से जोड दे ।

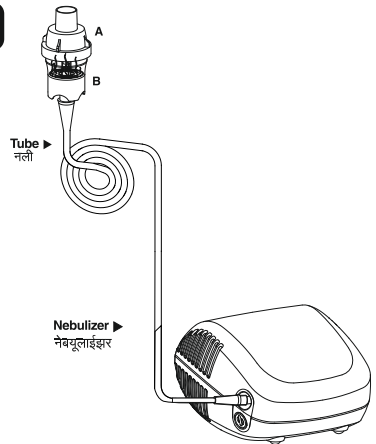

Keep machine off मशिन बंध रखिए

HOW TO USE STEP-5

Attach the Mouthpiece to the Medicine Bottle Cap. Start the Machine and take the Therapy as instructed by the Doctor.

कैसे उपयोग करे
कदम - ५

माउथपीस को दवाई की बोतल के ढक्कन के साथ जोड़ दें।
मशीन को चालू करें और डोक्टर के द्वारा बतायी गयी चिकित्सा ले।

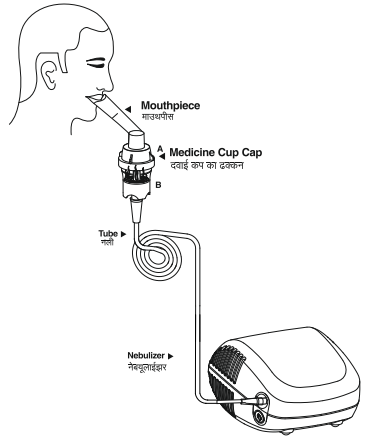

Start machine मशीन चालू किजिए

HOW TO USE STEP-6

Attach the Mask to the Medicine Bottle Cap. Start the Machine and take the Therapy as instructed by the Doctor. Keep Medicine cup vertical while in use.

कैसे उपयोग करे
कदम - 6

मास्क को दवाई की बोतल के ढक्कन से जोड़ ले।
मशीन चालू करें और डोक्टर द्वारा बतायी गयी चिकित्सा ले।

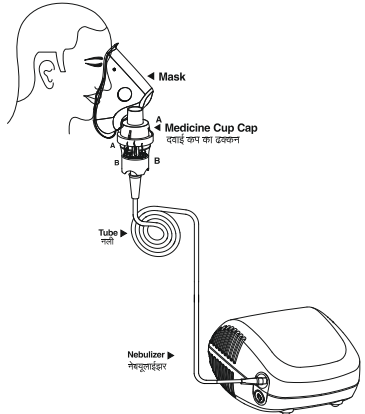

Start machine मशीन चालू किजिए

In case of problems with the device use the foll troubleshooting guide

| Problem | Cause | Remedy |
|---|---|--|
| Compressor does not start when the power switch is pressed.. | Power plug not plugged into a power outlet | Check that the plug is inserted in a power outlet. Unplug then reinsert the plug if necessary. |
| | Power not present in the power outlet socket | Check that there is power in the power outlet, also check the power present is same type as instructed in the machine bottom panel |
| The device is abnormally loud | Air filter covered or dirty | Attach the air filter cover correctly. |
| The device is very hot. | compressor covered, ventilation slots blocked | Do not cover the compressor with any type of cover during use. Do not block the ventilation slots. |
| No Nebulization or low nebulization rate, when the power is on and machine is working | No or low medicine in medicine cup | Add the correct amount of medication to the medication tank. |
| | Baffle missing or not assembled correctly (not applicable in nebulizer bottle with baffle integrated) | Attach the vaporizer head correctly. |
| | nebulizer kit assembled incorrectly | Assemble the nebulizer kit correctly. |
| | nozzle blocked | Make sure that the nozzle is free of blockages. |
| | nebulizer kit tilted at a sharp angle | Make sure that the nebulizer kit is not tilted at an angle of more than 45 degrees. |
| | Is the air tube folded ,creased or damaged or blocked | Make sure that the air tube does not contain kinks. Make sure that air tube is free of blockages. |
| | air filter dirty | Replace the air filter with a new one. |

 **Note:-** If the suggested remedy does not solve the problem, do not try to repair the device. Shut off the device for about 1 hour and then restart the machine. If the problem persists contact your Authorised service provider or manufacturer. Do not disassemble the unit yourself, no user serviceable parts inside, risk of electric shock.

 Before servicing by authorized service personnel. To completely isolate the device from the power source unplug the plug from the power source

WARRANTY CARD

HANDYNEB CLASSIC Nebulizer is made under strict quality control & utmost care is taken to ensure long, trouble free service.

- This unit is warranted for a period of 24 months from the date of purchase.
- This card must be duly filled in, stamped & signed by the dealer.
- This card & relevant invoice must be preserved and presented to the dealer when the unit is sent for repairs.
- We undertake to repair or replace at our discretion any part which was originally defective, provided the unit was not tampered with or mishandled.
- It shall be customer's responsibility to deliver the unit to the authorized service station; freight prepaid & collect the unit from service station after repairs.
- The warranty is only against manufacturing defects & shall not be applicable in case of damage due to accident, acts of nature, loss of components, intentional damage, improper installation or if it was opened or serviced by unauthorized persons.
- The warranty is void, if the set is not operated according to instructions given in the "Instruction Booklet", If any repair work is carried out by persons other than authorized company personnel, defects are caused by improper or reckless use, which shall be determined by company personnel.
- The warranty shall not extend towards the payment of compensation to anyone or entitle the customers to replacement of the products as a whole.
- The warranty expressly excludes every condition or warranty whether statutory or otherwise, or any claim for consequential loss or damage.
- Warranty does not cover accessories external to the equipment, defects caused due to causes beyond control like lighting, abnormal voltage, acts of God or while in transit to service center or to purchasers/premises.
- In the event of a defect being noticed in the equipment during the warranty period, the company or its authorized customer care center/service dealer reserves the right to retain any parts / or components replace at its discretion.
- **IMPORTANT:** Warranty is not applicable for kit and accessories components. Kit and accessories should be replaced from time to time as needed or as per doctor's advise.

Mfg. By

MEDTECH LIFE PRIVATE LIMITED

Regd. address : B6,Byculla Service Industries, D.K.Marg, Sussex Road, Byculla (East), Mumbai 400027, Maharashtra, INDIA.

Customer Care No.+917208088720

E-Mail:support@medtechlife.com

Website : www.medtechlife.com



Plot No. 05, Morai Industrial Park, S.No. 315/5, Morai, Valsad, Gujarat-396185



890609980S0H6LJ

EC REP OBELIS S.A.

Bd. Général Wahis 53, 1030 Brussels, BELGIUM

Tel.:+(32)2. 732.59.54 E-mail:mail@obelis.net

NEBULIZER

HANDYNEB CLASSIC

WARRANTY CARD

Subject to Mumbai Jurisdiction only

No.

Model

Serial No.

Invoice No. Date :

Stamp and Signature
of Dealer

Name and Address
of Dealer



“Nebukit” NEBULIZER KIT



Nebukit **2 parts bottle** has **advantage** over conventional 3 parts bottle. Nebukit **2 part bottle** has **fixed baffle** where as 3 parts bottle has **loose baffle** which may get lost and **Nebulization can not take place without baffle**. So ensure nebulization with 2 parts Nebukit bottle.

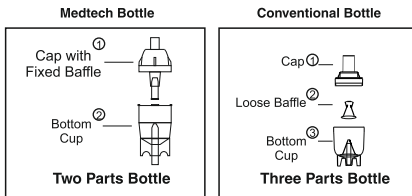

Insist on 2 Part Bottle “Nebukit” from your chemist, If you don’t get it Contact us on Number +91(022)-6657 8989 or you can buy online from shop.medtechlife.com